

WE KNOW CLEAN™

A FAMILY COMPANY SINCE 1967



# KODIAK®

*Cleaning Equipment*



## K10 COMPACT & STANDARD

### Unleash Your Full Cleaning Potential

**COMPACT  
FLOOR SCRUBBERS**

Made in the USA 

**AFFORDABLE &  
RELIABLE EQUIPMENT**



# PICK THE CHASSIS



## K10 STANDARD

This robust and budget friendly scrubber might be the last you have to buy! Durability of construction and powerful cleaning performance are our key goals when designing machines. Easily deliver clean floors in Fitness Centers, Car Shops, Fabrication Shops, and more. The scrub brushes are installed & removed without tools to allow ease when switching between application's needs. The squeegee blades can be rotated or flipped without tools. Ensure complete cleaning in a variety of sized applications with a reliable scrubber.

**Cleaning Path:** 17 - 20 in (43 - 51cm) | **Solution Tank Capacity:** 10gal (38L)  
**Run Time:** Up to 3 hours | **Recovery Tank Capacity:** 10gal (38L)



## K10 COMPACT

Cleaning small areas with a budget in mind has just gotten easier with Kodiak K10 Compact Scrubbers. Don't let the size fool you, this floor scrubber provides premium performance and durability compared to others in the market. Maintain cleanliness in Auto Shops, Sports Arenas, and Small Warehouses easily. Available as a 17" or 20" disk size. Run time up to 3 hours with a 10 gallon capacity for solution and recovery water.

**Cleaning Path:** 17 - 20 in (43 - 51cm) | **Solution Tank Capacity:** 10gal (38L)  
**Run Time:** Up to 2.5 hours | **Recovery Tank Capacity:** 10gal (38L)

## TANK TIPS



Access batteries, pumps and motors without any tools!

## EASY BRUSH ACCESS



K10 Standard: Remove shroud, raise Deck.



K10 Compact: Tip Machine Back.

## CHASSIS SIZE COMPARISON

 = **K10 STANDARD**

 = **K10 COMPACT**



Side View

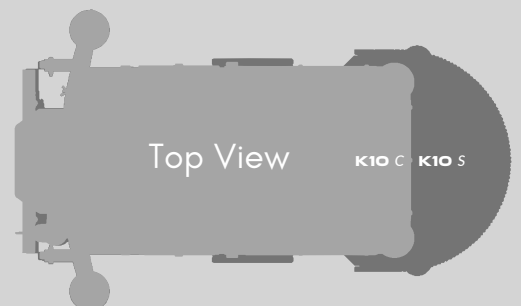

Top View

K10 C K10 S

# PICK THE DECK

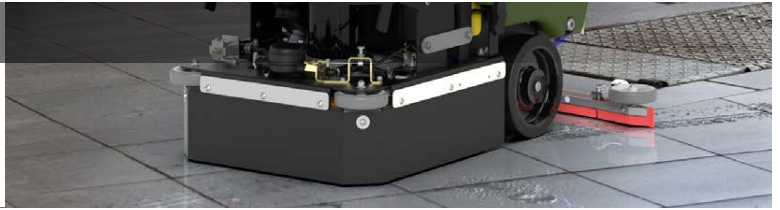

## DISK PAD-ASSIST SCRUB DECK

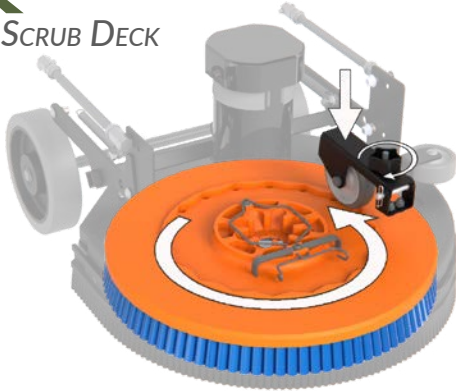

### Benefits

- Lowest Maintenance Cost
- Improved Cleaning on Irregular Floors
- Brush / Pad Selection
- Brushes Individually-Driven for Unmatched Performance



17 in PA Disk Deck on K10 Standard

## DISK TRACTION-DRIVE SCRUB DECK

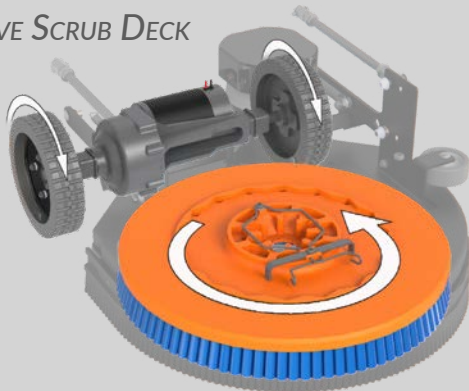

### Benefits

- Powered Reverse
- Ramp Climbing
- Operator Ease
- Brush / Pad Selection
- Improved Cleaning on Irregular Floors



20 in Traction Disk Deck on K10 Compact

## ORBITAL SCRUB DECK

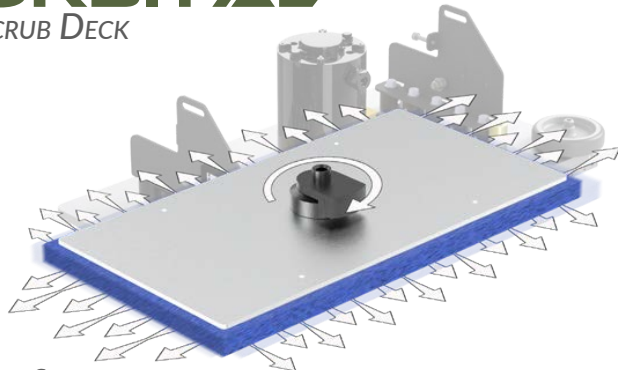

### Benefits

- Chemical Free Stripping
- Reduce Slip & Fall Potential
- 70% Reduction in Water Usage
- Consistent Results – No Swirl Marks
- VCT Prep & Recoat



20 in Orbital Deck on K10 Standard

\*Orbital Decks are not available on K10 Compact



# PICK THE OPTIONS



## **DRAIN SAVERS** & DELUXE FILL OPTIONS

Conveniently fill the floor scrubber fresh water tank from any standard faucet with the 60 inch retractable hose. Drain saver basket keep your Recovery tanks debris free, and simple to remove for disposal.



## **ON-BOARD** BATTERY CHARGER

Charge anywhere in the facility with a plug and forget charger. LED Indicator lights shows state of charge and historic charge cycle data can be downloaded for review.



## **WET / AGM** BATTERY OPTIONS

Choose between a variety of battery options for optimal run and charge times based on the application and needs.



## **FLIP WAND** 3 MAIN FUNCTIONS

- Apply Solution
- Scrub the ground with manual scrub brush
- Powerful suction recovers water into the recovery tank.

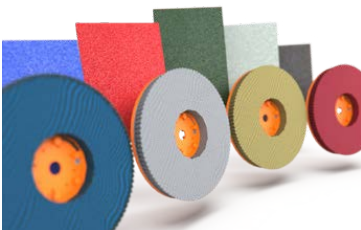

## **BRUSHES** & PADS

Depending on the floor, the right Brush or Pad can make or break the cleaning performance. Luckily there are a number of selections to ensure the best performance to match the floor type.

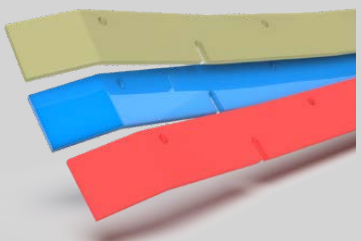

## **SQUEEGEES** 3 MATERIAL CHOICES

- Gum Rubber (Low Cost)
- Urethane (Oil Resistant)
- Linatex (Abrasion Resistant)



# TAKE A LOOK INSIDE



Front Fill Port

Stainless Vac Screen

Float Ball (Foam)

See-through Cover

White Vac Filter

Adjustable Handlebars



Vac Exhaust

Removable Shroud

Pad Assist

Non-Marking Tires

All Steel Frame

Poly Battery Box

Water In

Air Out

## RECOVERY TANK VAC PROTECTION SYSTEM

As the tank fills, the Float Ball rises until it is sucked into a sealed position, cutting off airflow to the vacuum motor.

*\*Drain Saver Basket is an option*

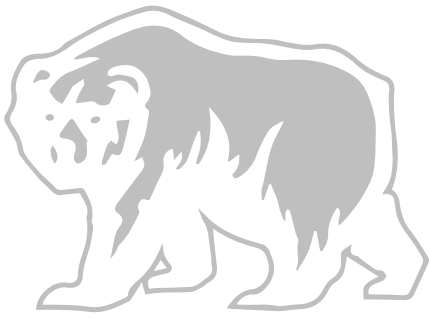

## Technical Data KODIAK K10 STANDARD & COMPACT AT A GLANCE

SPECIFICATION	K10 STANDARD	K10 COMPACT
Disk Scrub Path	17 & 20 in (43 & 51 cm)	17 & 20 in (43 & 51 cm)
Orbital Path	20 in (51 cm)	N/A
Dimensions (L x W x H) <small>*Dimensions listed are for the largest width deck configuration and squeegees removed from the machine.</small>	42 x 21 x 39 in* 107 x 53 x 99 cm*	35 x 18 x 38 in* 89 x 46 x 96 cm*
Solution Tank	10 Gallons (37 L)	10 Gallons (37 L)
Recovery Tank	10 Gallons (37 L)	10 Gallons (37 L)
Demisting Chamber	1 Gallon (4 L)	1 Gallon (4 L)
Run Time <small>*Based on continuous scrubbing run times, standard batteries, low down pressure and all options off.</small>	Up to 3 Hours*	Up to 2.5 Hours*
Coverage Per Hour <small>*Coverage is based off of ISSA 2010 Cleaning Times</small>	15,748 ft <sup>2</sup> /charge* (1,463 m <sup>2</sup> /charge*)	15,748 ft <sup>2</sup> /charge* (1,463 m <sup>2</sup> /charge*)
Coverage Per Charge <small>*Coverage is based off of ISSA 2010 Cleaning Times</small>	47,244 ft <sup>2</sup> /charge* (4,389 m <sup>2</sup> /charge*)	31,496 ft <sup>2</sup> /charge* (2,926 m <sup>2</sup> /charge*)

Please Note: Specifications and features subject to change without notice.



### WHY CHOOSE KODIAK?

Kodiak Cleaning Equipment specializes in durable equipment that will last for years to come. If you are tired of purchasing a new floor scrubber every year, you have come to the right place! We would love to get in contact with you and provide a complimentary Site Survey and Demonstration. Finally a quality alternative to used, reconditioned, demoed or cheap imported products that break and lack local support. Kodiak is assembled with American Labor and has parts and technical support 2nd to none. Comparable in price to mid-lower segment equipment, but not cheaply made. Reduced cost to build due to simplicity in design, leveraging excess production capacity and brought to market with exhibiting resources.

A FAMILY COMPANY SINCE 1967



## WE KNOW CLEAN™

EQUIPMENT PARTS RENTALS SERVICE SUPPLIES

[SWEEPERLAND.COM](http://SWEEPERLAND.COM)

Corporate Headquarters | 4713 Gettysburg Road | Mechanicsburg, PA 17055

Contact Us Today: 1-800-626-7835