



 EQUIPMENT

 PARTS

 RENTALS

 SERVICE

 SUPPLIES

USE AND MAINTENANCE MANUAL

CONTACT US

 800.6.Bortek

 717.737.7591

 Orders@BortekIndustries.com

 BortekIndustries.com/CUSTOMERLINK



HAMMERHEAD[®] 550RDX

USE AND MAINTENANCE MANUAL

550RDXB

ED. 03-2013

EN

ORIGINAL
INSTRUCTIONS
Doc. 10035670
AC Version



The descriptions contained in this document are not binding.
The company therefore reserves the right to make any modifications at any time to elements, details, or accessory supply, as considered necessary for reasons of improvement or manufacturing/commercial requirements.
The reproduction, even partial, of the text and drawings contained in this document is prohibited by law.

The company reserves the right to make any technical and/or supply modifications. The images are for reference purposes only, and are not binding in terms of design and supply.

Symbols used in the manual



Open book symbol with an "i"
Indicates the need to consult the instruction manual

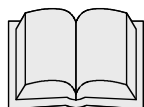

Open book symbol
Used to tell the operator to read the manual before using the machine



Warning symbol
Carefully read the sections marked with this symbol and observe the indications, for the safety of the operator and the machine



Warning symbol
Indicates danger of gas exhalation and leakage of corrosive liquids



Warning symbol
Indicates operator should take safety measures to avoid damage to limbs.



Warning symbol
Indicates the danger of fire.
Do not go near with free flames



Warning symbol
Indicates that the packed product should be handled with suitable lifting means that comply with the legal requirements



Disposal symbol
Carefully read the sections marked with this symbol for machine disposal



CONTENTS

ON CONSIGNMENT OF THE MACHINE 5

SERIAL NUMBER PLATE 5

INTRODUCTORY COMMENT 5

INTENDED USE 5

TECHNICAL DESCRIPTION 6

SYMBOLS USED ON THE MACHINE 8

GENERAL SAFETY REGULATIONS 9

MACHINE PREPARATION 10

 1. HANDLING OF THE PACKED MACHINE 10

 2. HOW TO MOVE THE MACHINE 10

 3. INSTRUMENT PANEL ELEMENTS 11

 4. STEERING COLUMN ELEMENTS 11

 5. FOOTBOARD ELEMENTS 11

 6. SIDE MACHINE ELEMENTS 12

 7. REAR MACHINE ELEMENTS 12

 8. FRONT MACHINE ELEMENTS 13

 9. TYPE OF BATTERY 13

 10. BATTERY MAINTENANCE AND DISPOSAL 13

 11. HANDLING - INSERTING BATTERIES 14

 12. BATTERY CONNECTION AND BATTERY CONNECTOR 15

 13. BATTERY CHARGER CONNECTION (VERSIONS WITHOUT BC) 15

 14. BATTERY CHARGER CONNECTION (VERSIONS WITH BC) 16

 15. BATTERY CHARGE LEVEL INDICATOR 16

 16. HOUR METER 17

 17. FORWARD WORK SPEED 17

 18. SOLUTION TANK 17

 19. FILLING THE SOLUTION TANK 18

 20. REGULATING THE DETERGENT 18

 21. RECOVERY TANK 18

 22. ASSEMBLING THE SQUEEGEE 18

 23. ADJUSTING THE SQUEEGEE INCLINATION 19

 24. ADJUSTING THE SQUEEGEE HEIGHT 19

 25. ASSEMBLING THE BRUSHES 19

 26. BLINKING LIGHT (OPTIONAL) 20

 27. EMPTY SOLUTION TANK DEVICE 20

WORK 21

 28. WORK 21

 29. "ECO" DEVICE 22

 30. OVERFLOW DEVICE 22

 31. EMERGENCY BUTTON 22

AT THE END OF THE WORK 23

 32. AT THE END OF THE WORK 23

DAILY MAINTENANCE 25

 33. CLEANING THE RECOVERY TANK 25

 34. CLEANING THE RECOVERY TANK FLOAT 25

 35. CLEANING THE SQUEEGEE 26

 36. CLEANING THE SOLUTION TANK FILTER 26

WEEKLY MAINTENANCE 28

 37. CLEANING THE VACUUM HOSE 28

 38. CLEANING THE BRUSH 28

EXTRAORDINARY MAINTENANCE 29

 39. REPLACING THE FRONT SQUEEGEE RUBBER 29

 40. REPLACING THE REAR SQUEEGEE RUBBER 29

 41. REPLACING THE BRUSH 29



TROUBLESHOOTING	30
42. THE MACHINE DOES NOT START	30
43. INSUFFICIENT WATER ON THE BRUSHES	30
44. THE SQUEEGEE DOES NOT DRY PERFECTLY	30
45. THE MACHINE DOES NOT CLEAN WELL	30
46. EXCESSIVE FOAM PRODUCTION	30
47. THE SUCTION MOTOR DOES NOT FUNCTION	30
48. THE BRUSH MOTOR DOES NOT WORK	30
DISPOSAL	31
CHOOSING AND USING THE BRUSHES	32
EC DECLARATION OF CONFORMITY	ERROR! BOOKMARK NOT DEFINED.

On consignment of the machine

When the machine is consigned to the customer, an immediate check must be performed to ensure all the material mentioned in the shipping documents has been received, and also to check the machine has not suffered damage during transportation. If this is the case, the carrier must ascertain the extent of the damage at once, informing our customer service office. It is only by prompt action of this type that the missing material can be obtained, and compensation for damage successfully claimed.

Introductory comment

550RDXB is a floor scrubbing machine which, by means of the mechanical action of the rotating brush and the chemical action of a water/detergent solution, can clean any type of flooring. As it advances, it also collects any removed dirt as well as the detergent solution not absorbed by the floor.

The machine must only be used for this purpose. Even the best machines will only work well if used correctly and kept in good working order. We therefore suggest you read this instruction booklet carefully and read it again whenever difficulties arise while using the machine. If necessary, remember that our customer assistance service (organised in collaboration with our dealers) is always available for advice or direct intervention.

Intended use

The scrubbing machine is designed exclusively for the professional cleaning of surfaces and floors in industrial, commercial and public environments. The machine is only suitable for use in closed - or at least covered - locations.

The machine is not suitable for use in the rain, or under water jets. It is **FORBIDDEN** to use the machine for picking up dangerous dusts or inflammable liquids within places with a potentially explosive atmosphere. In addition, it is not suitable as a means of transport for people or objects.

Serial number plate

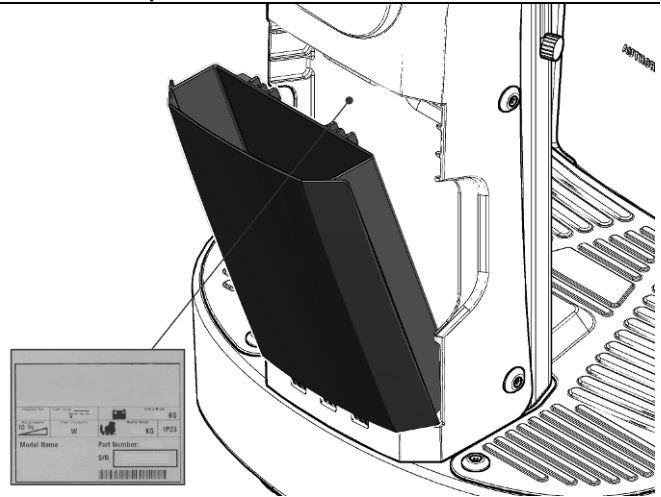



TECHNICAL DESCRIPTION	UM [SI]	550RDXB
Working width	mm	560
Squeegee width	mm	705
Squeegee width optional	mm	800
Working capacity, up to	m ² /h	2632
Disc brush	∅No. / ∅ mm	1 / 560
Disc brush rotations	rpm	140
Brush motor	V/W	24 / 450
Maximum pressure on the brushes	kg	15
Traction motor	V / W	24 / 300
Traction wheel (number / diameter / width)	No. / (∅ mm / mm)	2 / (225 / 64)
Maximum forward speed	km/h	5
Maximum gradient with full load	%	8
Vacuum motor	No./(V/W)	1 / (24 / 310)
Suction vacuum	mbar	700
Front elastic wheel (diameter / width)	∅ mm / mm	175 / 60
Solution tank	l	65
Recovery tank	l	75
Steering diameter	mm	1980
Machine length	mm	1265
Machine length with optional item-holder tray	mm	1400
Machine height	mm	1030
Machine height with optional blinking light kit	mm	1070
Machine width (without squeegee)	mm	600
Machine width (without squeegee) with optional tool-holder kit	mm	620
Battery compartment (l x L x h)	mm	362x354x290
Rated battery voltage	V/Ah	12 / 105
Machine transport weight (machine + batteries)	kg	190
Machine weight (empty and without batteries)	kg	110
Gross weight in running order (machine + batteries + water + operator)	kg	335
Sound pressure level (ISO 11201) - L _{pA}	dB (A)	63
Uncertainty - K _{pA}	dB (A)	1.4
Hand vibration level (ISO 5349)	m/s ²	<2.5
Body vibration level (ISO 2631)	m/s ²	<0.5
Vibration measurement uncertainty value		4%



TECHNICAL DESCRIPTION	UM _[SCS]	550RDXB
Working width	in	22
Squeegee width	in	27.76
Squeegee width optional	in	31.5
Working capacity, up to	ft ² /h	28330
Disc brush	∅No. / ∅ in	1 / 22
Disc brush rotations	rpm	140
Brush motor	V/W	24 / 450
Maximum pressure on the brushes	lbs	33
Traction motor	V / W	24 / 300
Traction wheel (number / diameter / width)	No. / (∅in / in)	2 / (8.86 / 2.52)
Maximum forward speed	mph	3.11
Maximum gradient with full load	%	8
Vacuum motor	No./(V/W)	1 / (24 / 310)
Suction vacuum	mbar	700
Front elastic wheel (diameter / width)	∅ in / in	6.89 / 2.36
Solution tank	gallons	17
Recovery tank	gallons	19
Steering diameter	in	77.95
Machine length	in	49.80
Machine length with optional item-holder tray	in	55.12
Machine height	in	40.55
Machine height with optional blinking light kit	in	42.12
Machine width (without squeegee)	in	23.62
Machine width (without squeegee) with optional tool-holder kit	in	24.41
Battery compartment (l x L x h)	in	14.25 x 13.94 x 11.42
Rated battery voltage	V/Ah	12 / 105
Machine transport weight (machine + batteries)	lbs	418
Machine weight (empty and without batteries)	lbs	242
Gross weight in running order (machine + batteries + water + operator)	lbs	738
Sound pressure level (ISO 11201) - L _{pA}	dB (A)	63
Uncertainty - K _{pA}	dB (A)	1.4
Hand vibration level (ISO 5349)	m/s ²	<2.5
Body vibration level (ISO 2631)	m/s ²	<0.5
Vibration measurement uncertainty value		4%

SYMBOLS USED ON THE MACHINE

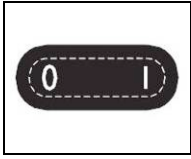

Main switch or key switch symbol
Used on the instrument panel, to indicate the key switch for machine operation on (I) or off (0)



Symbol denoting acoustic alarm
Used to indicate the acoustic alarm button

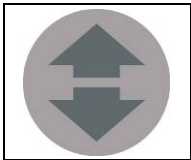

Symbol of the reverse movement selector
Used to indicate the button for engaging the reverse gear



Brush coupling/uncoupling symbol
Used to indicate the button that couples or uncouples the brush



ECO mode symbol
Used to indicate the button that activates the ECO mode of the machine

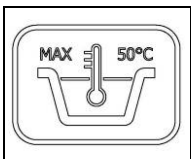

Symbol indicating the maximum temperature of the water used to fill the solution tank



Symbol indicating the position of the solution tank drain pipe



Symbol indicating the position of the recovery tank drain pipe

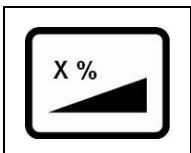

Indicates the maximum gradient



GENERAL SAFETY REGULATIONS

The regulations below must be carefully followed in order to avoid harm to the operator and damage to the machine.

WARNING:

- Read the labels on the machine carefully. Do not cover them for any reason and replace them immediately if they become damaged.
- The machine must be exclusively used by authorised, trained personnel.
- Do not use the machine on surfaces with an inclination greater than the one shown on the plate.
- The machine is not suitable for cleaning rough or uneven floors. Do not use the machine on slopes.
- If the power supply cable of the battery charger is damaged, contact an Authorised service centre immediately.
- In the event of danger, quickly press the emergency button on the command panel.
- For all maintenance interventions, switch off the machine and disconnect the battery connector and/or the power supply cable.
- Children must be supervised to ensure they do not play with the device.
- During the working of the machine, pay attention to other people and especially to children.
- Only use the brushes supplied with the machine, or those specified in the "CHOOSING AND USING THE BRUSHES" paragraph of the instruction manual. The use of other brushes could compromise safety levels.

WARNING:

- The machine is not suitable for use by children and persons with reduced physical, mental and sensory capabilities, or people who lack experience and knowledge.
- The machine must not be used or stored outdoors, in damp conditions or directly exposed to rain.
- The storage temperature must be between -25°C and +55°C; do not store outdoors in damp conditions.
- Conditions of use: room temperature between 0°C and 40°C with relative humidity between 30 and 95%.
- The socket for the machine's power cable (electric version) or for the battery charger power cable (battery version) must be correctly earthed.
- Adapt the speed to the adhesion conditions.
- Do not use the machine as a means of transport.
- The machine does not cause harmful vibrations.
- Do not use the machine in an explosive atmosphere.
- Do not vacuum inflammable liquids.
- Do not use the device to collect dangerous powders.
- Do not mix different types of detergent as this may produce harmful gases.
- The machine is not suitable for cleaning carpets.
- Do not place any liquid containers on the machine.
- Avoid working with the brushes when the machine is standing still, so as not to damage the floor.
- In the event of a fire, use a powder extinguisher. Do not use water.
- Do not knock against shelving or scaffolding, where there is a danger of falling objects. The operator must always be equipped with the appropriate safety devices (gloves, shoes, helmet, goggles, etc.).
- The machine is designed to carry out the scrubbing and drying operations simultaneously. Different operations should only be carried out in areas where the passage of unauthorised persons is prohibited. Signal the presence of damp floors with suitable signs.
- If the machine does not work properly, check this is not caused by failure to carry out routine maintenance. Otherwise, ask for intervention of the authorised technical assistance centre.
- If you need to replace any components, request the ORIGINAL spare parts from an Authorised dealer and/or Retailer.
- Restore all electrical connections after any maintenance interventions.
- Before using the machine, check that all the hatches and covers are positioned as shown in this Use and Maintenance Manual.
- Do not remove the guards that can only be removed with the aid of tools, except for maintenance work (see the relevant paragraphs)
- Do not wash the machine with direct water jets or with pressurised water, nor with corrosive substances.
- To prevent scaling in the solution tank filter, do not fill the tank with detergent solution many hours before using the machine.
- Do not use acid or basic solutions that could damage the machine and/or harm people.
- Have the machine checked by an authorised technical assistance centre every year.
- When disposing of consumable materials, observe the laws and regulations in force.
- When your machine has reached the end of its long working life, dispose of the materials it contains (especially oils, batteries and electronic components) in an appropriate manner, taking into account that the machine itself was constructed using 100% recyclable materials.
- The batteries must be removed from the machine before its disposal. The batteries must be disposed of in a safe manner, fully observing the laws and regulations in force.

MACHINE PREPARATION

1. HANDLING OF THE PACKED MACHINE

The machine is contained in specific packaging with a pallet for the handling with fork trucks. The packages cannot be placed on top of each other. The total weight of the machine and packaging is 135kg. The dimensions of the packaging is as follows:

550RDXB

- A :** 1200 mm
- B :** 660 mm
- C :** 1430 mm

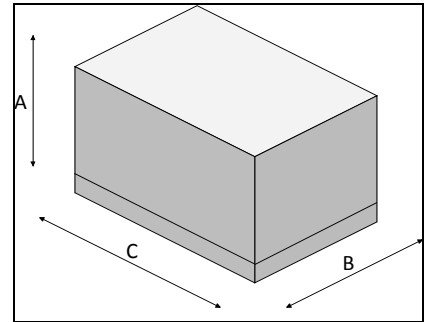

1. Remove the outer package
2. The machine is fixed to the pallet with wedges which block the wheels
3. Disengage the electronic brake, turn the lever (1) (on the rear right-hand side of the machine) clockwise
4. Remove the wedges

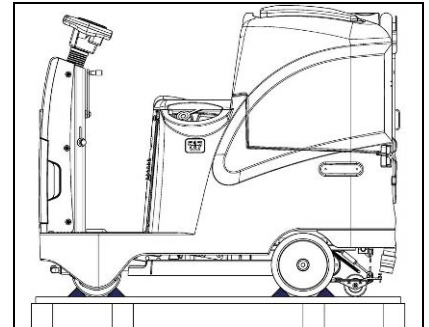

5. Use a chute to get the machine down from the pallet, pushing it backwards. Do not assemble the rear squeegee before unloading the machine, and avoid violently jolting the brush head. To assemble the squeegee, read the "ASSEMBLING THE SQUEEGEE" paragraph.

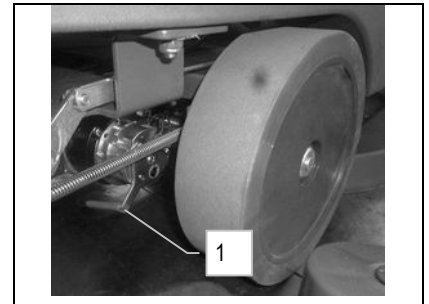

ATTENTION: During transportation, the electrical brake should not be engaged, the machine will in any event, if the critical speed threshold is crossed, activate the internal braking system of the chopper circuit board and will emit a warning noise.

6. Keep the pallet for any future transport needs



WARNING: If the product is delivered in cardboard containers, handle the packed product with suitable lifting means that comply with the legal requirements



WARNING: During this operation, check there are no people or objects near the machine

2. HOW TO MOVE THE MACHINE

1. Check the solution tank and recovery tank are empty; if necessary, empty them
2. Check that the brush head and squeegee are in the raised position
3. Place it on a pallet using a chute
4. Check that the key switch is in the "0" position and remove the key
5. Secure the machine to the pallet using wooden wedges
6. Engage the electronic brake

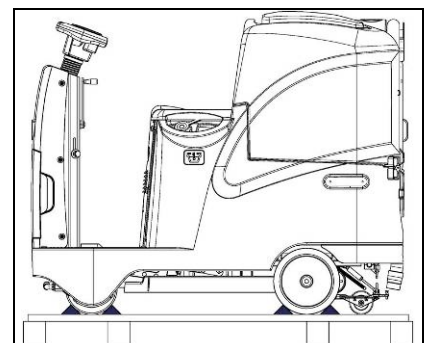

MACHINE PREPARATION

3. INSTRUMENT PANEL ELEMENTS

The instrument panel components are identified as follows:

1. Level indicator for battery/hour meter
2. Horn button

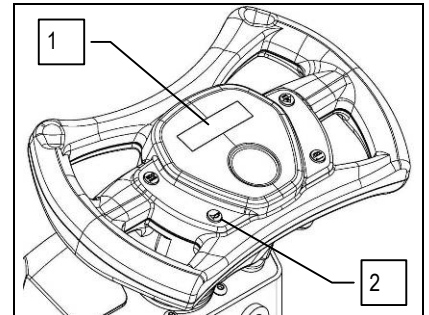

3. Reverse button
4. Brush coupling/uncoupling button
5. "ECO" function button

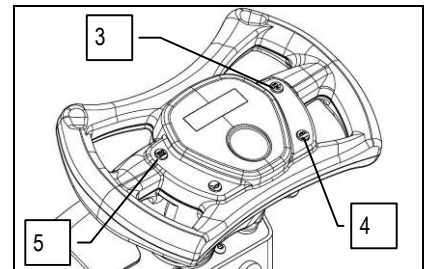

4. STEERING COLUMN ELEMENTS

The elements on the left side of the steering column are:

6. Squeegee body lifting lever
7. Brush head body lifting lever

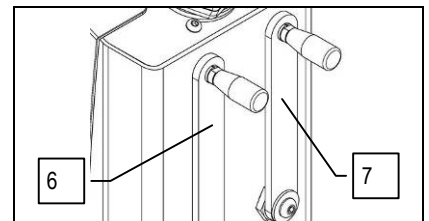

8. Detergent solution adjustment lever

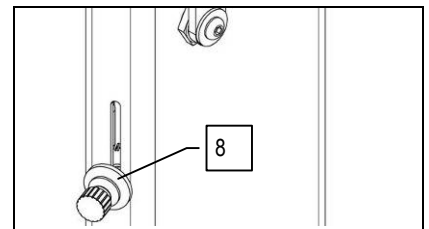

9. Main key switch

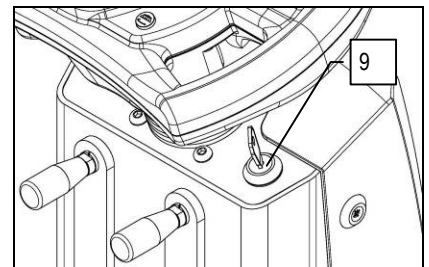

5. FOOTBOARD ELEMENTS

The components on the front right part of the footboard are:

10. Drive pedal

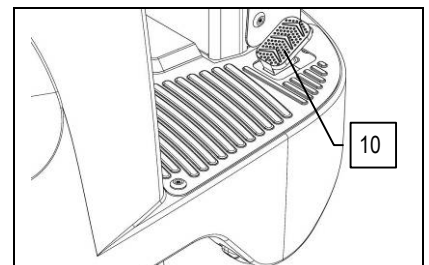

MACHINE PREPARATION

The components on the rear part of the footboard are:

- 11. Emergency button
- 12. Detergent solution level tube

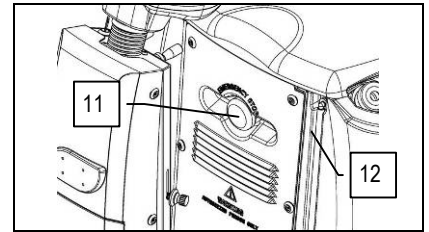

- 13. Recovery tank release button

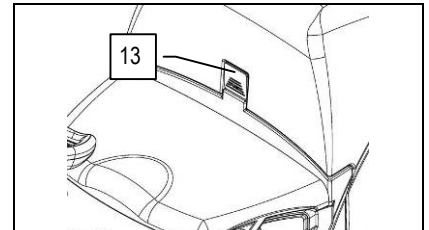

6. SIDE MACHINE ELEMENTS

The elements on the left-hand side of the machine are:

- 14. Fast water-detergent filling cap
- 15. Water-detergent filler cap

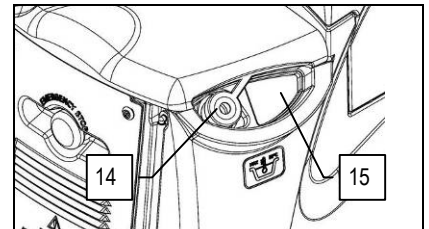

- 16. Handle support kit (optional)

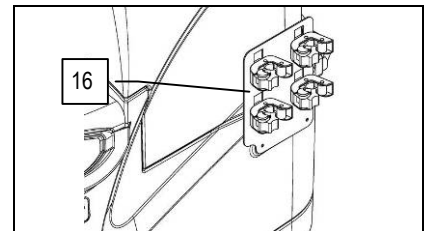

7. REAR MACHINE ELEMENTS

The elements on the rear of the machine are:

- 17. Recovery tank cover
- 18. Blinking light (optional)

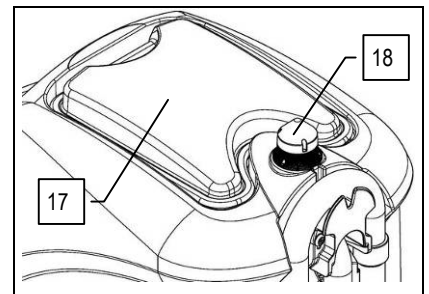

- 19. Recovery tank drain pipe
- 20. Squeegee vacuum tube

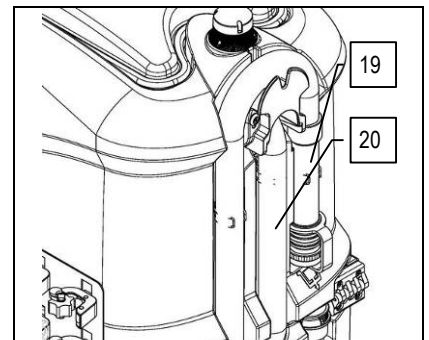

MACHINE PREPARATION

8. FRONT MACHINE ELEMENTS

The elements on the front of the machine are:

- 21. Item-holder tray
- 22. Storage compartment carter

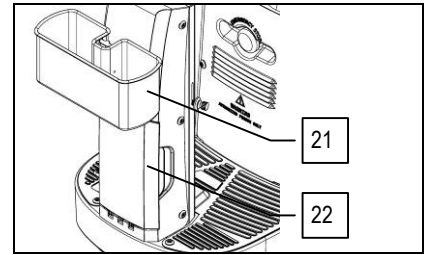

- 23. Detergent solution filter

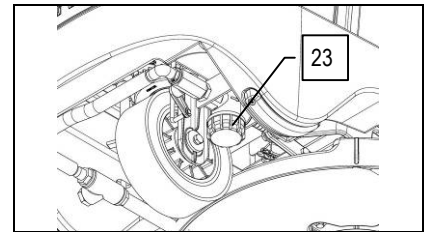

- 24. Detergent tank drainage tap

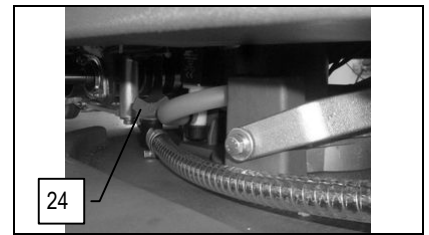

9. TYPE OF BATTERY

To power the machine it is necessary to use:

- liquid-electrolyte lead traction batteries
- sealed traction batteries with gas recombination or gel technology.

OTHER TYPES MUST NOT BE USED.

The batteries must meet the requirements laid out in the norms: CEI EN 60254-1:2005-12 (CEI 21-5) + CEI EN 60254-2:2008-06 (CEI 21-7)

For a good operating performance, we suggest the use of two 12V - 105 Ah/C5 batteries



10. BATTERY MAINTENANCE AND DISPOSAL

For maintenance and recharging, respect the instructions provided by the battery manufacturer.

Particular attention must be paid when choosing the battery charger, if not supplied, since there are different kinds according to the type and capacity of the battery.

When the battery reaches the end of its working life, it must be disconnected by expert, trained personnel then removed from the battery compartment with the aid of suitable lifting devices. DEAD BATTERIES ARE CLASSIFIED AS DANGEROUS WASTE AND MUST BE DELIVERED TO THE AUTHORISED BODIES FOR CORRECT DISPOSAL.



WARNING: You are advised to always wear protective gloves, to avoid the risk of serious injury to your hands.



WARNING: You are advised to only lift and move the batteries with lifting and transportation means suitable for the specific weight and size

MACHINE PREPARATION

11. HANDLING - INSERTING BATTERIES

The batteries must be housed in the special compartment beneath the seat carter. They should be handled using lifting equipment that is suitable in terms of both weight and coupling system. They must also satisfy the requirements of Standard CEI 21-5. The dimensions of the battery compartment are: 362mm x 354mm x H290mm.



WARNING: For battery maintenance and daily recharging, you must carefully follow the instructions provided by the manufacturer or retailer. All installation and maintenance operations must be carried out by specialised personnel.



WARNING: You are advised to use airtight batteries only, to avoid the leakage of acids!



WARNING: You are advised to always wear protective gloves, to avoid the risk of serious injury to your hands.

To insert batteries proceed as follows:

1. Check the main switch is in the "0" position, if this is not the case, turn the key by a quarter of a turn to the left.
2. Lock the machine by activating the electronic brake, then turn the lever (1) (on the rear right-hand side of the machine) anticlockwise
3. Make sure the recovery tank is empty, otherwise empty it completely
4. Press the button (2) to release and rotate the recovery tank

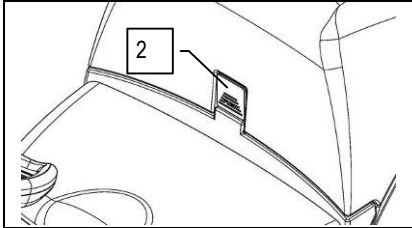
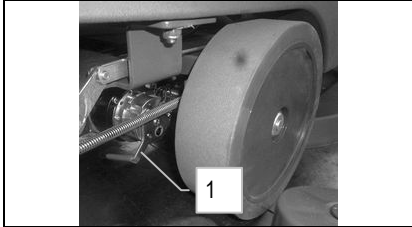

5. Grip the recovery tank and rotate it as far as it will go

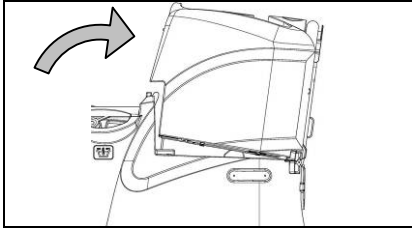

ATTENTION: You are advised to only lift and move the batteries with lifting and transportation means suitable for the specific weight and size

6. House the batteries in the compartment, positioning the poles "+" and "-" opposite each other

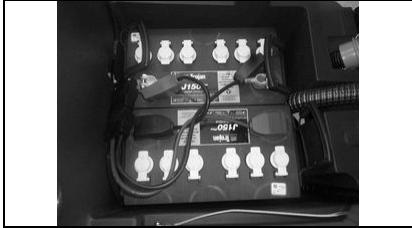

MACHINE PREPARATION

12. BATTERY CONNECTION AND BATTERY CONNECTOR

1. Connect the batteries in series to the "+" and "-" poles using the supplied jumper cable
2. Connect the battery connector cable to the "+" and "-" poles in order to obtain the terminal voltage of 24V
3. Connect the battery connector cable (2) to the machine connector (1)
4. Rotate the seat support until it is in the working position

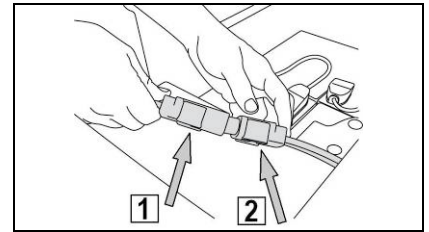

WARNING: All installation and maintenance operations must be carried out by expert personnel, trained at the specialised assistance centre

13. BATTERY CHARGER CONNECTION (VERSIONS WITHOUT BC)

In order not to cause permanent damage to the batteries, it is essential to avoid their complete discharge: arrange the recharge within a few minutes of the switching on of the "discharged batteries" blinking light.



WARNING: Never leave the batteries completely discharged, even if the machine is not being used. Check the battery charger is suitable for the batteries installed, in terms of both capacity and type.

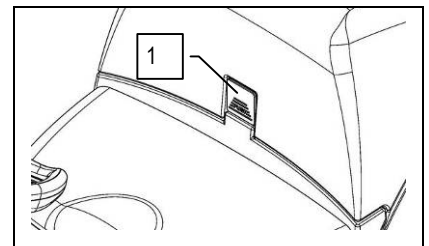

To connect the battery charger you must:

1. Move the machine near to the battery charger
2. Make sure the recovery tank is empty, otherwise empty it completely
3. Check the key switch is on "0"; if this is not the case, turn the key of the main switch anticlockwise to "0"
4. Press the button (1) to release and rotate the recovery tank
5. Grip the recovery tank and rotate it as far as it will go

The coupling connector of the battery charger is supplied inside the bag containing this instruction booklet, and must be fitted to the battery charger cables as shown in the instructions.

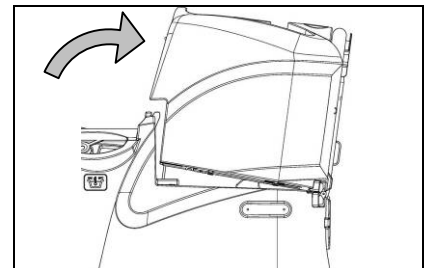

WARNING: This process must be carried out by qualified personnel. An incorrect connection of the connector may cause problems with machine functioning.

6. Disconnect the electric system connector from the battery connector
7. Connect the battery charger cable to the battery connector
8. Close the recovery tank until the gas spring (2) is resting on the solution tank



9. Connect the recently wired cable to the external battery charger



WARNING: Carefully read the use and maintenance instructions of the battery charger that is used for charging.



WARNING: Keep the recovery tank open for the duration of the battery recharging cycle to allow gas fumes to escape

10. After the charging cycle is complete, the battery connector must be connected to the machine connector

MACHINE PREPARATION



WARNING: Danger of gas exhalation and leakage of corrosive liquids.



WARNING: Danger of fire: do not go near with free flames

14. BATTERY CHARGER CONNECTION (VERSIONS WITH BC)

In order not to cause permanent damage to the batteries, it is essential to avoid their complete discharge: arrange the recharge within a few minutes of the switching on of the "discharged batteries" blinking light.



WARNING: Never leave the batteries completely discharged, even if the machine is not being used. Check the battery charger is suitable for the batteries installed, in terms of both capacity and type.

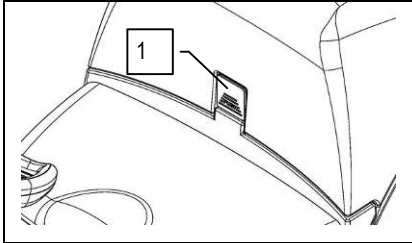

To connect the battery charger you must:

1. Move the machine near to the battery charger
2. Check the key switch is on "0"; if this is not the case, turn the key of the main switch anticlockwise to "0"
3. Press the button (1) to release and rotate the recovery tank
4. Grip the recovery tank and rotate it until the gas spring (2) is resting on the solution tank

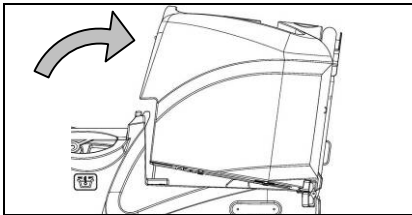

WARNING: This process must be carried out by qualified personnel. An incorrect connection of the connector may cause problems with machine functioning.

5. Connect the battery charger cable to the socket on the charger itself
6. Plug the battery charger cable into the mains socket.

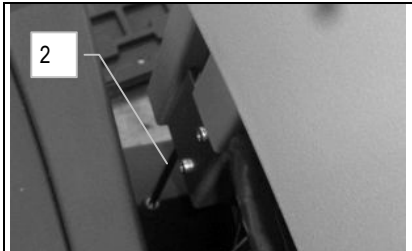

The battery charger power cable is delivered inside the bag containing this instruction booklet.



WARNING: Carefully read the use and maintenance manual of the charger that is delivered inside the bag containing this instruction booklet.

WARNING: Before inserting the charger power cable into the socket, verify that there is no condensate or other forms of liquids.



WARNING: if the machine's electric system is accidentally powered (by turning the main switch to ON), the commands display will show "BATTERY-CHARGER" and no steering wheel command will function.



15. BATTERY CHARGE LEVEL INDICATOR

On the instrument panel of the machine there is a monitor (1) indicating (amongst other things) the battery charge status. If the lower line contains ten light indicators, the battery charge level is 100%. If the battery charge percentage is at 00% and flashing, this means the batteries are discharged.



MACHINE PREPARATION



WARNING: a few seconds after the battery charge level reaches 20%, the brush motor switches off automatically. With the remaining charge it is still possible, however, to complete the drying process before recharging

WARNING: a few seconds after the battery charge level reaches 10%, the vacuum motor switches off automatically. With the remaining charge, it is still possible, however, to move the machine to the location designated for its recharging

16. HOUR METER

On the machine's instrument panel there is a display (1) indicating the total machine usage time. The top line shows the hours and minutes of functioning. The flashing ":" symbol indicates that the hour meter is counting the machine functioning time.



17. FORWARD WORK SPEED

This machine is equipped with electronic traction control. To move the machine, turn the key to "I" then press the drive pedal (1), adjusting the speed by altering the degree of pressure on the pedal.



ATTENTION! The machine will not start to move (either forwards or backwards) if the electrical brake is not engaged. In this case, you will see "ELECTRICAL BRAKE?" on the command display.

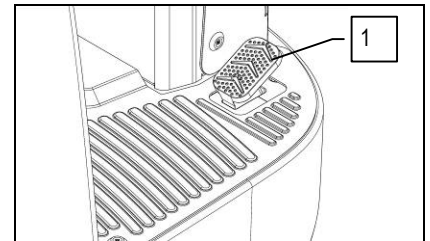

To move the machine backwards, press the button (2) on the instrument panel, then immediately press the pedal (1). Adjust the speed by altering the degree of pressure on the pedal.



WARNING! The reverse speed is lower than the forward speed to comply with current health and safety standards.

ATTENTION! The machine will not start to move in reverse if the squeegee is lowered.

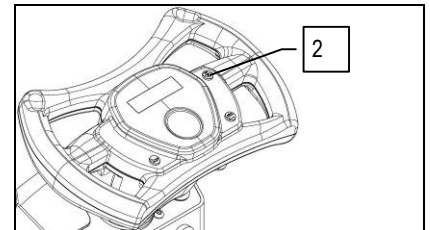

18. SOLUTION TANK

The recovery tank must be completely empty each time the solution tank is filled. Remove the inlet cap (1) located on the left side of the machine.



WARNING: The recovery tank must be completely empty each time the solution tank is filled.

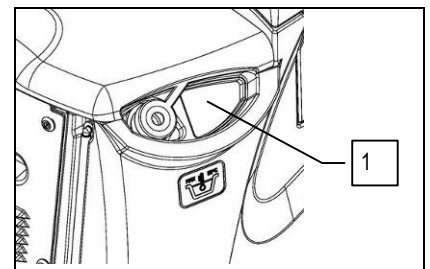

Check that the solution filter cap (2), under the solution tank in the front right of the machine, is properly closed.

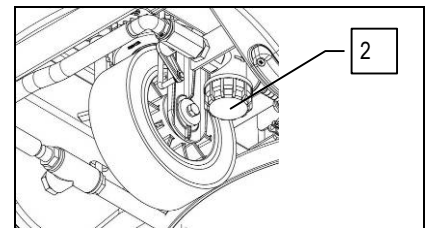

Check that the solution tank drainage tap (3) (under the solution tank in the right part of the brush head body) is well closed.

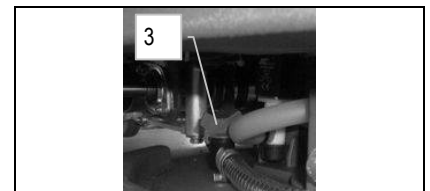

MACHINE PREPARATION

19. FILLING THE SOLUTION TANK

The solution tank can be filled in two different ways:

1. removing the inlet cap (1) and filling with the aid of a rubber tube
2. using the rubber cap (2); this supports the water hose on its own, but be sure to remove the inlet cap (1) to allow the proper vent of air.

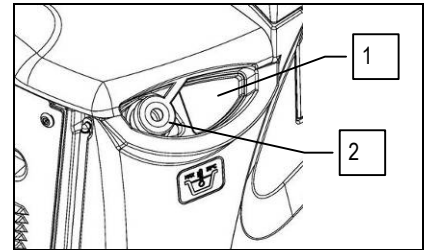

Remove the inlet cap (1) and fill with clean water at a temperature of not more than 50°C. The amount inside the tank can be seen by means of the level pipe on the front left of the seat. The solution tank has a maximum capacity of about 65 litres. Add the liquid detergent to the tank in the concentration and manner indicated on the detergent manufacturer's label. The formation of excess foam could damage the vacuum motor, so use only the minimum amount of detergent that is necessary.



WARNING: Always use detergents whose manufacturer's label indicates their suitability for scrubbing machines. Do not use acid or alkaline products or solvents without this indication. Acid or alkaline maintenance detergents can be used, as long as they have pH values between four and ten, and do not contain oxidising agents, chlorine or bromine, formaldehyde, mineral solvents.



WARNING: protective gloves should always be worn before handling detergents or acidic or alkaline solutions to avoid serious injury to hands.



ATTENTION: always use low foam detergent. To avoid the production of foam, before starting to clean, put a minimum quantity of anti-foam liquid into the recovery tank. Do not use pure acids.

20. REGULATING THE DETERGENT

Firstly, fully open the outflow of the tap, by means of the lever (1) on the steering column. During the first few metres, check that the amount of solution is sufficient to wet the floor. The amount can be adjusted by means of the lever (1), shifting it downwards to increase the flow, or upwards to reduce it. Bear in mind that the correct amount of solution is always depends on the nature of the floor, the degree of dirt and the forward speed.

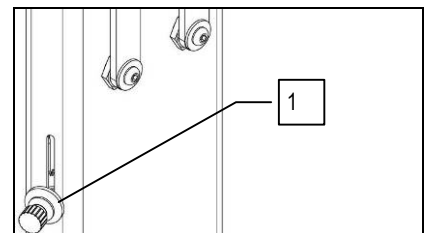

21. RECOVERY TANK

Make sure the recovery tank is empty, otherwise empty it completely.
Check the cap of the drainage tube (1) (on the rear of the machine) is correctly closed.

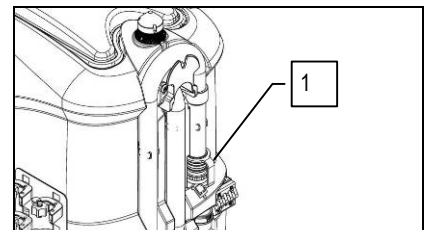

22. ASSEMBLING THE SQUEEGEE

The squeegee, that for reasons of packaging comes disassembled from the machine, must be assembled while assembling the machine. Proceed as follows for assembly:

1. Lift the squeegee, turning the left-hand lever (1) to move it clockwise
2. Turn the main switch key anticlockwise to the "0" position

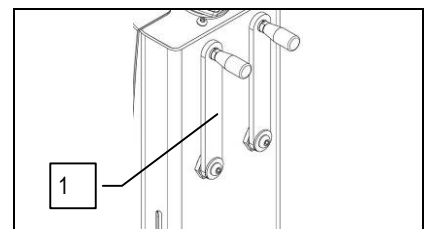

MACHINE PREPARATION

3. Remove the key from the instrument panel
4. Loosen the knobs (2) and (3) in the squeegee pre-assembly
5. Insert the left-hand squeegee pin in the left-hand slit of the squeegee connection, then tighten the knob (2), making sure the washer and spring adhere in the upper part of the squeegee support

6. Insert the right-hand squeegee pin in the right-hand slit of the squeegee connection, then tighten the knob (3), making sure the washer and spring adhere in the upper part of the squeegee support
7. Insert the vacuum hose (4) in the squeegee sleeve



ATTENTION: these operations must be carried out using protective gloves to avoid any possible contact with the edges or tips of metal objects.

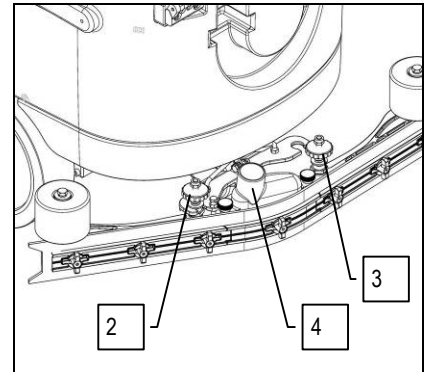

23. ADJUSTING THE SQUEEGEE INCLINATION

During working operation, the rear rubber is slightly tilted backwards (by about 5mm) in a uniform way for its whole length. If you need to increase the bend of the rubber in the central part, you must tilt the squeegee unit. To do this, proceed as follows:

1. Loosen the locknut (1)
2. Turn the screw (2) clockwise to increase the bend of the rubber in the central part of the squeegee.
3. When fully adjusted, fix the locknut (1)

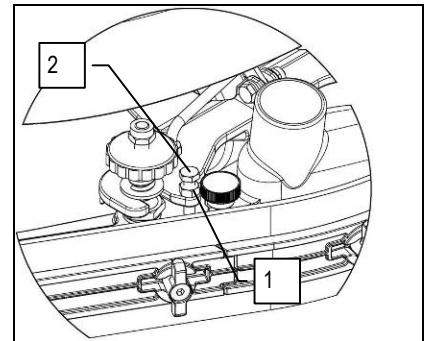

24. ADJUSTING THE SQUEEGEE HEIGHT

The height of the squeegee must be adjusted on the basis of the state of wear and tear of the rubber. Carry out the following operations for adjustment:

1. Loosen the locking nuts (1)
2. Raise or lower the wheels (2) by sliding them in the slot on the squeegee support
3. Block it by tightening the locking nuts (1) once the required height is reached.

NB: to facilitate the operation, completely lower the squeegee and put a spacer of a few millimetres (2 to 4 mm depending on the type of rubber) under the wheel.

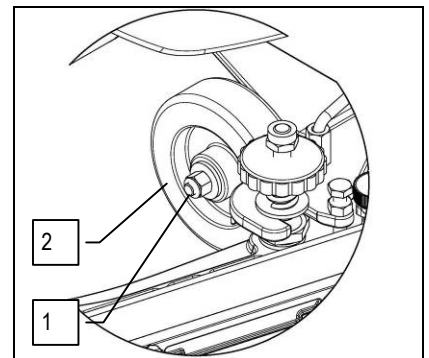

25. ASSEMBLING THE BRUSHES

To assemble the brushes of the brush head body, proceed as follows:

1. Lift the brush head by turning the right lever (1) to move the brush head anticlockwise
2. Turn the main switch key clockwise to the "1" position



WARNING: During this operation, check there are no people or objects near the brush.

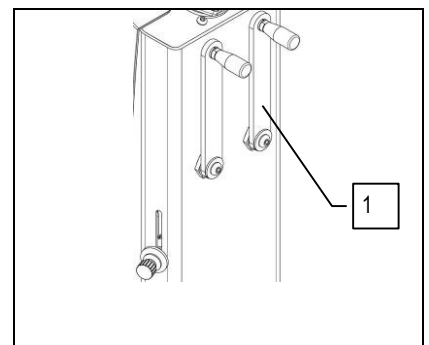

MACHINE PREPARATION

3. Position the brush on the floor, near the machine brush head
4. Lower the brush head, turning the right-hand lever (1) to move it clockwise.
5. Press the brush release button (2) intermittently

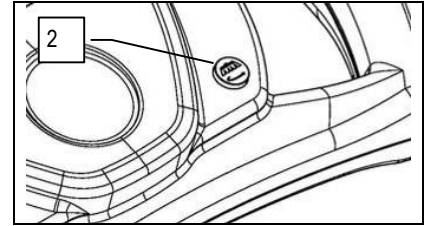

WARNING: During this operation, check there are no people or objects near the brush.

ATTENTION: Check the brush is correctly inserted. If this is not the case, the machine could move in an irregular, sudden manner.

26. BLINKING LIGHT (OPTIONAL)

The machine can be equipped with a blinking light that turns on automatically when the key in the main switch is turned on.



27. EMPTY SOLUTION TANK DEVICE

To check the quantity of water in the solution tank there is a suitable level indicator tube (1) placed in front of the driver seat.

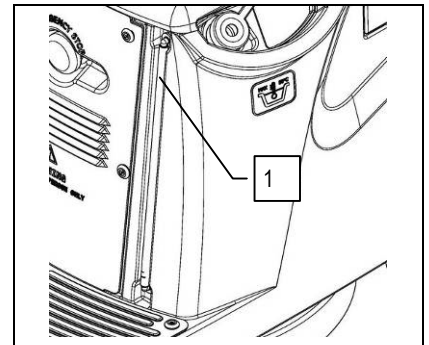

WORK

28. WORK

Before beginning to work, it is necessary to:

1. make sure the recovery tank is empty, otherwise empty it completely
2. check the key switch (3) is on "0"; if this is not the case, turn the key of the main switch anticlockwise to "0"
3. connect the battery connector (2) to the electric system connector (1)
4. Check the electronic brake (4) is engaged
5. sit on the driver's seat

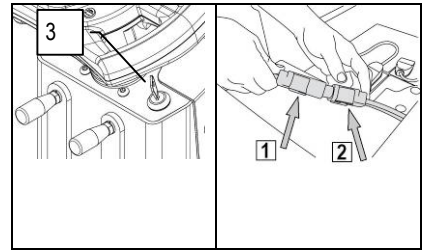

6. Turn the key of the main switch a quarter of a rotation clockwise (to position I). The display on the instrument panel will immediately come on.

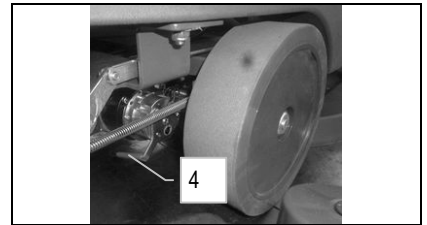

7. At switch-on, three consecutive screens are displayed on the monitor. The first shows the machine name on the top line. The program release number is shown on the bottom line.

8. The second screen shows the total functioning time on the top line. On the bottom line you can see what battery technology has been set for machine operation; in this case it is gel batteries (to set another type of battery - for instance acid - contact the qualified assistance centre personnel).



9. The third and last screen (known as "work") displays the battery charge status and the total functioning time. When the batteries supplied are fully charged, the bottom line contains ten light indicators that represent a battery. As the batteries gradually run down, the indicators go out and, with the batteries completely run down, only the battery outline flashes. The top line indicates the hours and minutes of functioning. The flashing ":" symbol indicates that the hour meter is counting the machine functioning time.

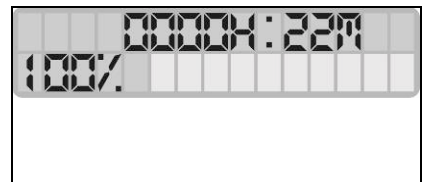

10. Move the tap lever (5) downwards and adjust to the desired solution quantity

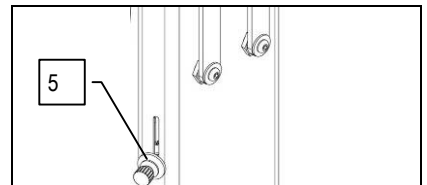

11. Lower the brush head by turning the right lever (6) clockwise, then lower the squeegee turning the left lever (7) anticlockwise.



WARNING: As soon as the forward movement pedal is activated with the brush head in its work position, the solenoid valve will start working and will begin dispensing detergent solution. As soon as the squeegee is in its work position, the vacuum motor will switch on and being working.

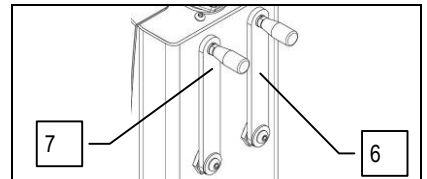

12. Press the accelerator pedal (8) to start moving the machine



WARNING: To stop the machine, remove your foot from the accelerator (8). The machine will begin to stop.

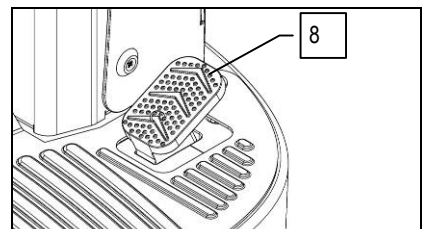

WORK

13. To make a reverse movement, press the button (9) on the steering wheel simultaneously with the pedal (8).



WARNING: During reverse movements, the squeegee must be lifted off the floor. To do this, turn the lever (7) clockwise.

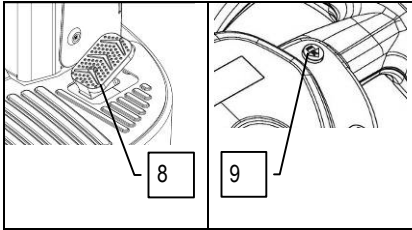

During the first metres, check there is sufficient solution and that the squeegee dries perfectly. The machine will now begin to work with full efficiency until the battery is flat or until the detergent solution has finished.

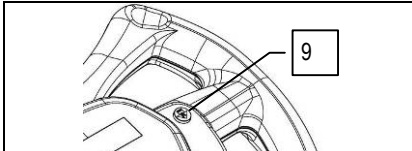

29. "ECO" DEVICE

The machine is equipped with an "ECO" function which increases the working capacity of the machine. Press the button (1) on the steering wheel to activate the "ECO" function; the battery display will show the word "ECO". When this function is activated, the power of the vacuum and brush motors is reduced and therefore also the noise level of the machine. Just press the button (1) on the steering wheel to deactivate the "ECO" function.

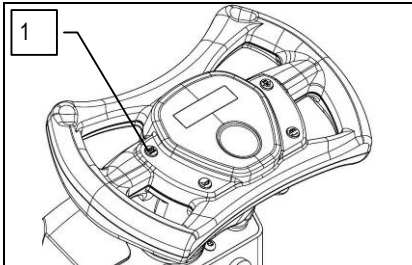

30. OVERFLOW DEVICE

The machine is NOT equipped with an overflow device, because the capacity of the recovery tank is greater than the capacity of the solution tank. In extraordinary cases, there is a mechanical device (float) on the lid that, when the recovery tank is full, shuts off the air to the suction motor intake TO protect it; the sound of the vacuum motor will then be deeper. In this case, raise the brush head and squeegee off the floor by means of the respective knobs on the steering column. After about 15-25 seconds, the vacuum motor will switch off. Then empty the recovery tank via the drainage hose (1). It is good practice when restoring the level of the solution tank, to empty the recovery tank through the special drainage pipe (1).

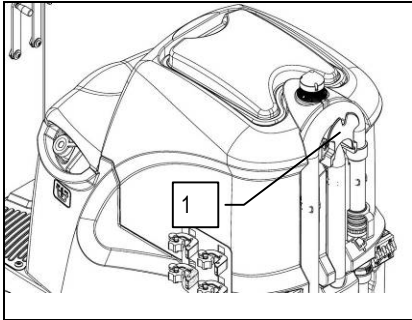

31. EMERGENCY BUTTON

If there are any problems while you are working, press the emergency button (1) beneath the seat. This command interrupts the electric circuit between the batteries and the machine system, so the machine stops and the electric brake is triggered. To resume work (after resolving the problem), switch off the key (2), move the button (1) to its standard position, then switch the key (2) back on again.

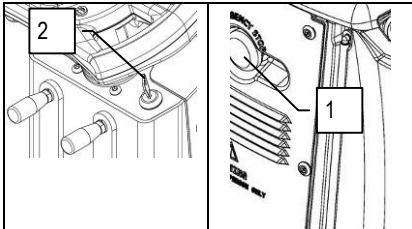

AT THE END OF THE WORK

32. AT THE END OF THE WORK

At the end of the work, and before carrying out any type of maintenance, perform the following operations:

1. Close the tap by moving the knob (1) upwards

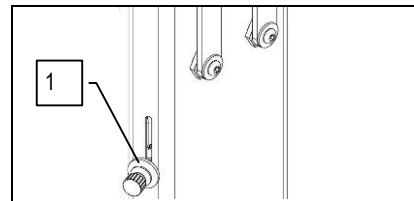

2. Lift the brush head by turning the right lever (2) anticlockwise, then lift the squeegee turning the left lever (3) clockwise. The vacuum motor switches off after a few seconds.

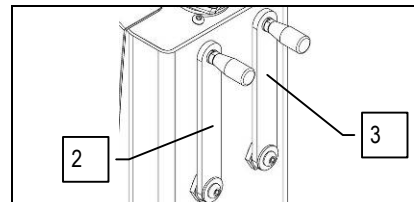

WARNING: If the brush head unit is raised up in ECO mode, the vacuum motor will return to standard mode to allow the floor to dry properly.

3. Bring the machine to the place provided for draining the water
4. Turn the machine off by turning the key one quarter turn anticlockwise and remove it from the panel.



WARNING: Before performing any maintenance, remove the keys from the panel and disconnect the battery connector of the machine.

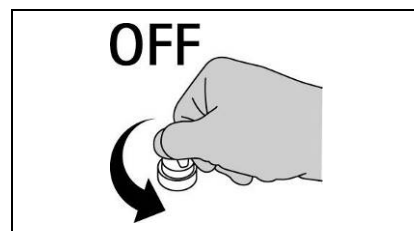

5. Disconnect the tube (4) from its seat, unscrew the drainage cap and empty the recovery tank.



WARNING: This operation must be carried out using gloves to protect against contact with dangerous solutions.

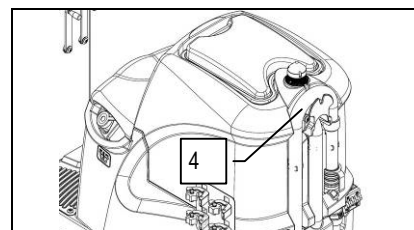

6. Slide the vacuum tube (5) from the squeegee sleeve
7. Remove the squeegee from the support arm (6) by unscrewing the handwheels (7).
8. Clean well both the squeegee and the rubbers with a jet of water.

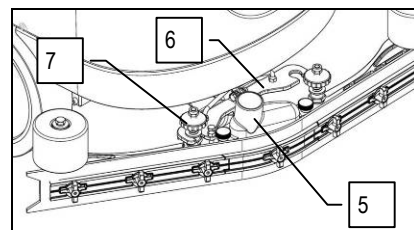

9. After cleaning the squeegee and rubbers, replace the squeegee on the initial support, firstly inserting the left pin of the squeegee in the left slot of the arm, then the right pin in the right slot, being careful to keep the spring and washer on the plate of the arm. This can be simplified by first loosening the handwheel on the pin. Tighten the handwheel to lock the squeegee in place.
10. Finally insert the squeegee tube in the special sleeve.

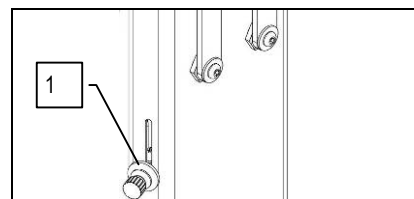

11. If you need to empty the solution tank, move the knob (1) downwards
12. Lower the brush head body by means of the relevant lever on the steering column
13. Move the tap (8) outside the brush head body
14. Rotate the tap (8) anticlockwise and wait until the solution tank is empty
15. Close the tap (8) and reposition it on the brush head body
16. Raise the brush head body by means of the relevant lever on the steering column

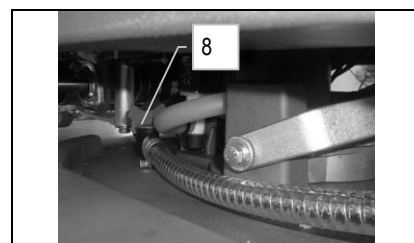

AT THE END OF THE WORK

17. sit on the driver's seat
18. Insert the key into the main switch block and turn it a quarter turn clockwise (to position I)
19. Park the machine in a closed place, in an area where it cannot cause damage to people or other property, but also be protected from an accidental fall of objects.
20. Turn the key switch a quarter turn anticlockwise (position "0") and remove the key

21. Lift the recovery tank and disconnect the battery connector



WARNING: do not leave the machine unattended without first removing the start-up switch key and applying the parking brake. In addition, do not park the machine in open places or on sloping floors.

DAILY MAINTENANCE

PERFORM ALL MAINTENANCE OPERATIONS IN SEQUENCE

33. CLEANING THE RECOVERY TANK

1. Disconnect the tube (1) from its seat, unscrew the drainage cap and empty the recovery tank.
2. Press the button (2) to release and rotate the recovery tank

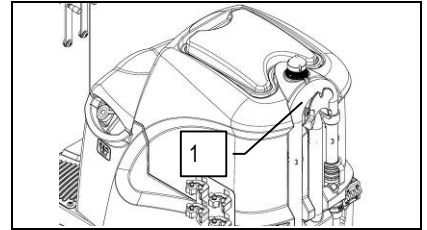

WARNING: Before performing any maintenance, remove the keys from the panel and disconnect the battery connector of the machine.



ATTENTION: this operation must be carried out using gloves to protect against contact with dangerous solutions.

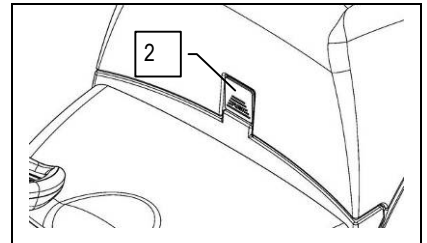

3. Grip the recovery tank and rotate it until the gas spring is resting on the solution tank
4. Remove the vacuum cover (3) and place it in the rear part of the machine (see figure)
5. Clean and rinse the recovery tank.
6. Replace the cap on the drainage hose, then replace the vacuum cover.
7. Rotate the recovery tank to its standard position

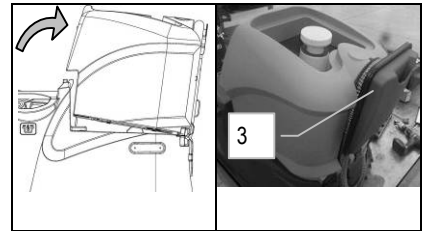

WARNING: Be careful not to hit the recovery tank float directly, as this would enable water to enter the vacuum motor connected to it.

34. CLEANING THE RECOVERY TANK FLOAT

1. Press the button (1) to release and rotate the recovery tank

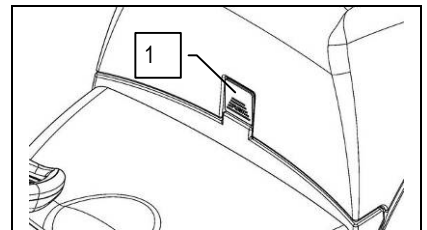

2. Grip the recovery tank and rotate it until the gas spring is resting on the solution tank
3. Remove the vacuum cover (2) and place it in the rear part of the machine (see figure)

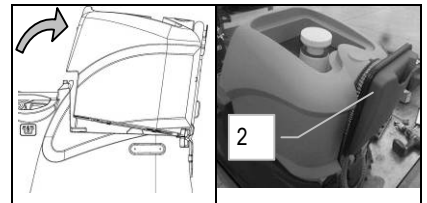

4. Remove the float pre-assembly (3) by rotating it anticlockwise

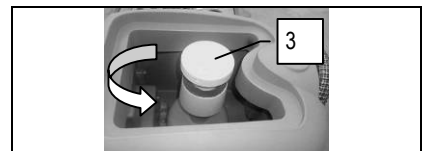

DAILY MAINTENANCE

5. Remove the float cover (4)

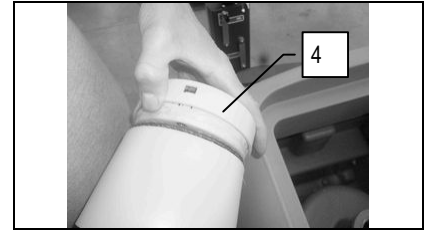

6. Remove the vacuum filter (5) from the float body
7. Clean the filter and float body with a jet of water
8. Reassemble all the elements

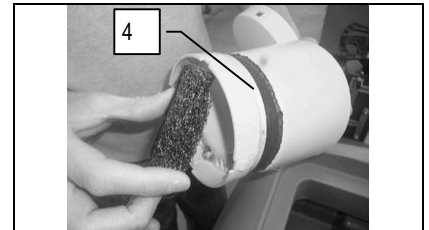

35. CLEANING THE SQUEEGEE

The careful cleaning of the whole vacuum unit ensures better drying and cleaning of the floor as well as greater duration of the vacuum motor. Proceed as follows for cleaning:

1. Slide the vacuum tube (1) from the squeegee sleeve.
2. Remove the squeegee (2) from the support arm by unscrewing the handwheel (3).
3. Use a damp cloth to clean the front and rear rubbers, and also clean the vacuum chamber of the squeegee body

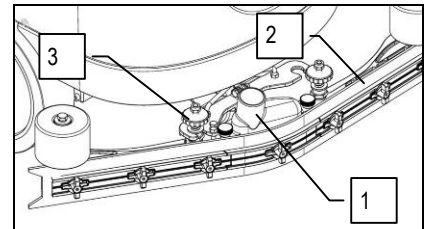

ATTENTION: this operation must be carried out using gloves to protect against contact with dangerous solutions.

4. Check the wear of the rubbers. If the edge of the rubber is badly damaged, the rear rubber (6) can be turned on all four edges. If the rubbers are completely worn proceed with the replacement. To remove the rubber, turn the wing nuts (4) in a horizontal position, remove the rubber-pressing blades (5) and then remove the rubber to turn it or replace it.

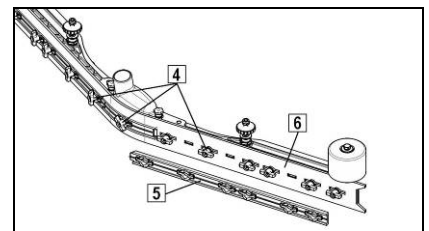

5. Clean the vacuum nozzle (7). To do this, remove it from the squeegee body by rotating the knobs (8) anticlockwise
6. Reassemble the vacuum nozzle on the squeegee body

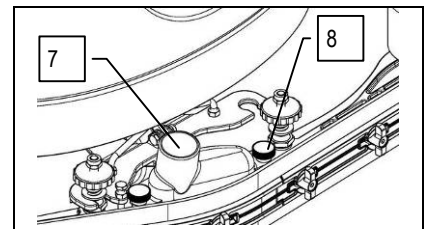

7. After cleaning, replace the squeegee (2) on the initial support, firstly inserting the left pin of the squeegee in the left slot of the arm, then the right pin in the right slot, being careful to keep the spring and washer on the plate of the arm. This can be simplified by first loosening the handwheel (3) on the pin. Then tighten the handwheel (3) to lock the squeegee in place
8. Insert the squeegee tube in the appropriate sleeve (1).

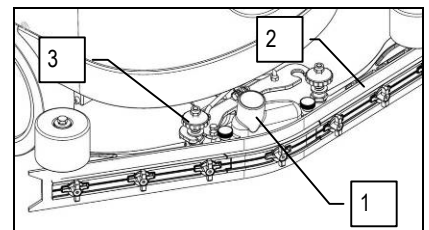

36. CLEANING THE SOLUTION TANK FILTER

Careful cleaning of the detergent/water solution filter ensures a better working capacity. Proceed as follows for cleaning:

1. Check the main switch is on "0" (turn it to this position if necessary)
2. Open the filler cap (1)

DAILY MAINTENANCE



WARNING: Before performing any maintenance, remove the keys from the panel and disconnect the battery connector



WARNING: These operations must be carried out using gloves to protect against contact with dangerous solutions.

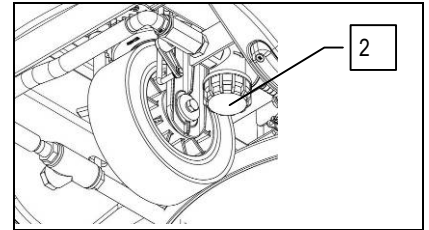
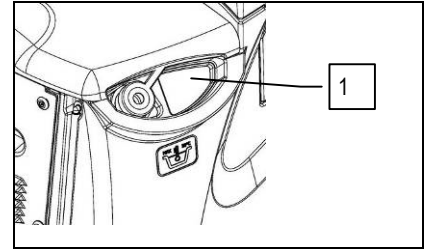

3. Close the water tap by shifting the relevant knob (on the left part of the steering column) upwards
4. Loosen the filter cap (2) on the front of the machine
5. Remove the internal filter cartridge and rinse everything thoroughly with running water
6. Reassemble all the elements

WEEKLY MAINTENANCE

37. CLEANING THE VACUUM HOSE

Whenever vacuum seems to be unsatisfactory, check that the vacuum tube is not obstructed. If necessary clean with a jet of water as follows:

1. Make sure the recovery tank is empty, otherwise empty it completely
2. Check the main switch is on "0" (turn it to this position if necessary)
3. Disconnect the vacuum hose from the squeegee nozzle (1)

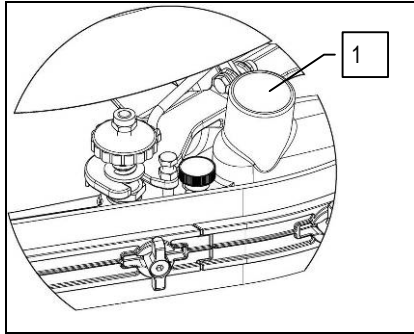

WARNING: This operation must be carried out using gloves to protect against contact with dangerous solutions.

4. Detach the aspiration tube from the seat on the recuperation tank (2)
5. Clean it with a water jet introduced from the side where it is connected to the tank
6. Reassemble all the elements

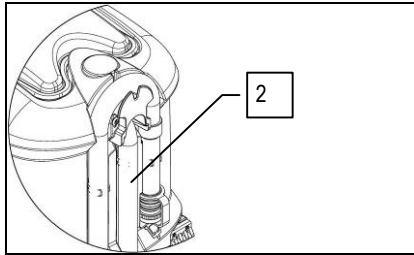

38. CLEANING THE BRUSH

Thorough cleaning of the brush will guarantee a better working capacity. Proceed as follows for cleaning:

1. Check the main switch is on "1" (turn it to this position if necessary)
2. Raise the brush head by turning the right-hand lever (1) anticlockwise

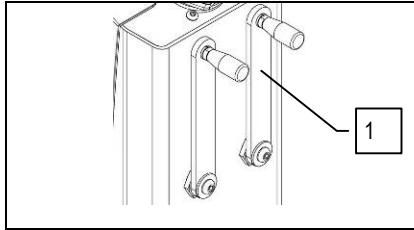

3. Press the brush release button (2) on the steering wheel

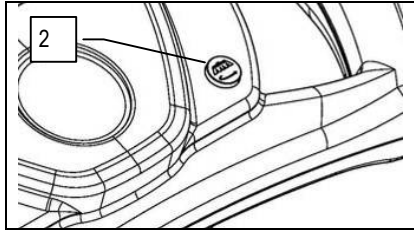

4. As soon as the button is pressed, you will see the question "RELEASE?" on the screen
5. Press the brush release button (2) on the steering wheel again, to confirm

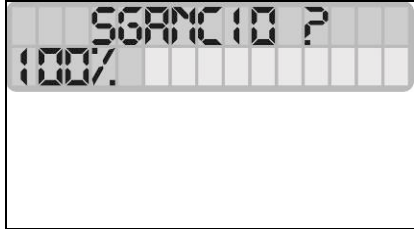

WARNING: During this operation, check there are no people or objects near the brush.

6. Take the brush and clean it under a flowing jet of water
7. Reassemble it on the brush head body

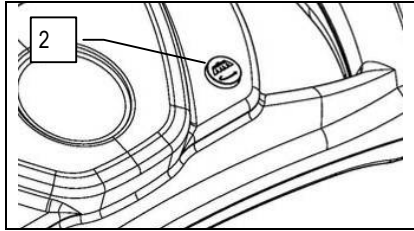

EXTRAORDINARY MAINTENANCE

39. REPLACING THE FRONT SQUEEGEE RUBBER

Vacuum will be poor and the machine will not dry perfectly if the front squeegee rubber is worn. Proceed as follows to replace:

1. Check the main switch is on "0" (turn it to this position if necessary)
2. Disconnect the squeegee by loosening the knobs (1)



WARNING: Before performing any maintenance, remove the keys from the panel and disconnect the battery connector

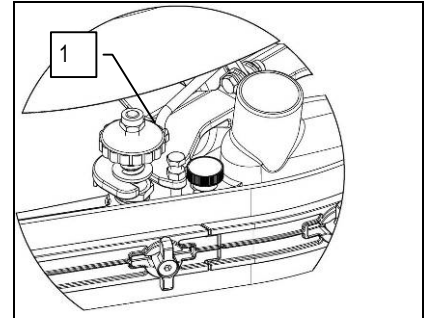

3. Turn the wing nuts (2) in the horizontal position
4. Remove the front rubber-pressing blades (3)
5. Remove the rubber (4) and replace it
6. To replace the rubber, proceed in reverse order



WARNING: These operations must be carried out using gloves to protect against contact with dangerous solutions.

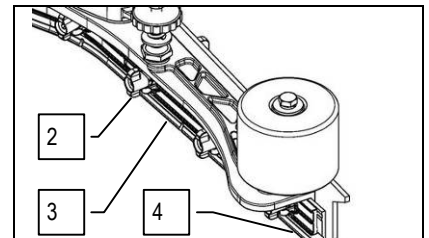

40. REPLACING THE REAR SQUEEGEE RUBBER

If the squeegee rear rubber is worn and does not dry well, it is possible to change the drying edge using one of the 4 edges of the rubber.

This can be done with the squeegee removed, proceeding as follows:

1. Check the main switch is on "0" (turn it to this position if necessary)
2. Disconnect the squeegee by loosening the knobs (1)



WARNING: Before performing any maintenance, remove the keys from the panel and disconnect the battery connector

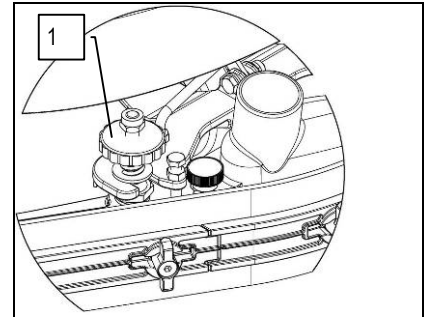

3. Turn the wing nuts (2) in the horizontal position
4. Remove the rear rubber-pressing blades (3) and then the rubber, to turn it over or replace it
5. To replace the rubber, proceed in reverse order
6. Adjust the height of the squeegee depending on the rubber (see "ADJUSTING THE HEIGHT OF THE SQUEEGEE SUPPORT")



WARNING: These operations must be carried out using gloves to protect against contact with dangerous solutions.

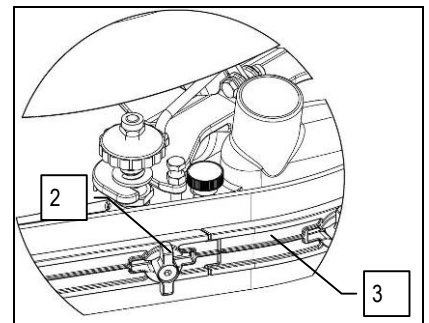

41. REPLACING THE BRUSH

An undamaged brush ensures a better working capacity, to replace it proceed as follows:

1. Check the main switch is on "1" (turn it to this position if necessary)
2. Raise the brush head by turning the right-hand lever (1) anticlockwise, then press the brush release button (2) on the steering wheel
3. As soon as you press the button, you will see "RELEASE?" on the screen. Press the brush release button (2) on the steering wheel again, to confirm
4. Take the brush and replace it



WARNING: During this operation, check there are no people or objects near the brush.

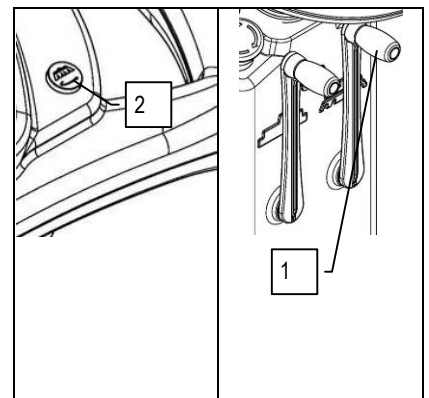

TROUBLESHOOTING

42. THE MACHINE DOES NOT START

1. Check that batteries are charged
2. Make sure the electric system connector is connected to the battery connector
3. Check the key switch is ON/I

43. INSUFFICIENT WATER ON THE BRUSHES

1. Check there is water in the solution tank
2. Check that the water/detergent solution release adjustment knob (1) is open
3. Clean the solution filter (2) located at the front of the machine

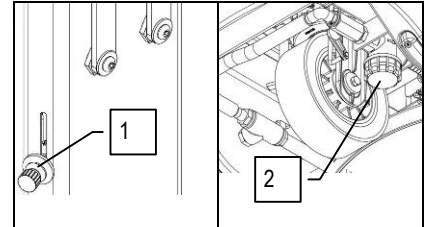

44. THE SQUEEGEE DOES NOT DRY PERFECTLY

1. Check the squeegee is clean
2. Check the squeegee settings (see "MACHINE PREPARATION")
3. Clean the entire vacuum unit (see "WEEKLY MAINTENANCE")
4. Replace the rubbers, if worn

45. THE MACHINE DOES NOT CLEAN WELL

1. Check the state of wear and tear of the brushes and, if necessary, replace them. The brushes should be changed when the bristles are about 15mm long. To replace them, see "REPLACING THE BRUSHES", or "DISASSEMBLING THE BRUSHES" and "ASSEMBLING THE BRUSHES". Working with over-worn brushes may cause damage to the floor.
2. Use a different kind of brush to the one fitted as standard. For cleaning floors where the dirt is particularly resistant, we recommend the use of special brushes supplied upon request and according to needs (see "CHOOSING AND USING THE BRUSHES").

46. EXCESSIVE FOAM PRODUCTION

Check that a low foam detergent has been used. If necessary, add a small quantity of antifoam liquid to the recovery tank.

Remember that, when the floor is not very dirty, more foam is generated. In this case the detergent solution should be more diluted.

47. THE SUCTION MOTOR DOES NOT FUNCTION

1. Check whether the recovery tank is full and, if necessary, empty it
2. Check the float switch on the suction cap (see also "CLEANING THE RECOVERY TANK" in the paragraph "DAILY MAINTENANCE")

48. THE BRUSH MOTOR DOES NOT WORK

WARNING To avoid damaging the floor, the motor only starts up when the machine is moved forwards

1. Check that the base is lowered during start-up
2. The operator must be properly seated in the driving position
3. Check no thermal protection device has intervened.
4. Check the correct connection of the motor to the terminal under the footboards.



DISPOSAL

To dispose of the machine, take it to a demolition centre or an authorised collection centre.

Before scrapping the machine it is necessary to remove and separate the following materials and send them to the appropriate collection centres in accordance with the environmental hygiene regulations currently in force:

- brushes
- felt
- electric and electronic parts*
- batteries
- plastic parts (tanks and handlebars)
- metal parts (levers and frame)

(*) In particular, to scrap the electric and electronic parts, contact your area distributor.



CHOOSING AND USING THE BRUSHES

POLYPROPYLENE BRUSH (PPL)

Used on all types of floor, it has good resistance to wear and tear and hot water (no greater than 60°C). PPL is non-hygroscopic and therefore retains its characteristics even when working in wet conditions.

NYLON BRUSH

Used on all types of floors. Excellent resistance to wear and tear, and hot water (even over 60°C). The nylon is hygroscopic and so tends to lose its characteristics over time when working in wet conditions.

ABRASIVE BRUSH

The bristles of this type of brush are charged with highly aggressive abrasives. It is used to clean very dirty floors. To avoid floor damage, work only with the pressure strictly necessary.

THICKNESS OF THE BRISTLES

Thicker bristles are more rigid and are therefore used on smooth floors or floors with small joints.

On uneven floors or those with deep joints, it is advisable to use softer bristles which can enter the gaps more easily.

Remember that when the bristles are worn and therefore too short, they will become rigid and are no longer able to penetrate and clean deep down, also because, like with over-large bristles, the brush tends to jump.

PAD HOLDER

The pad holder is recommended for cleaning shiny surfaces.

There are two types of pad holder:

1. The traditional pad holder is fitted with a series of anchor points that allow the abrasive floor pad to be held and dragged while working.
2. The CENTER LOCK type pad holder not only has anchor points, but also a snap-type central locking system in plastic that allows the abrasive floor pad to be perfectly centred and held without any risk of it becoming detached. This type of holder is especially suitable for machines with several brushes, where the centring of the abrasive floor pads is difficult.

TABLE FOR CHOOSING THE BRUSHES

Machine	No. of brushes	Code	Type of bristles	∅ Bristle	∅ Brush	Length	Notes
550RDXB	1	436232	PPL	0.3	560	-	LIGHT BLUE BRUSH
		436233	PPL	0.6			WHITE BRUSH
		436234	PPL	0.9			BLACK BRUSH
		436235	ABRASIVE	0.9			BRUSH
		436236	-		535	-	PAD HOLDER



HAMMERHEAD®



450**RS**



500**RS**



500**SS**



600**SS**



650**RS**



750**RS**



550**RDX**



650**RDX**



700**RSX**



750**RDX**



870**SR**

HEADQUARTERS

4713 Old Gettysburg Road
Mechanicsburg, PA 17055 USA

CONTACT US

☎ 800.6.Bortek

☎ 717.737.7591

✉ Orders@BortekIndustries.com

🌐 BortekIndustries.com/CUSTOMERLINK

SWEEPERLAND.COM

A complete family of
power cleaning machines.